

**STANLEY**<sup>®</sup>  
Security Solutions

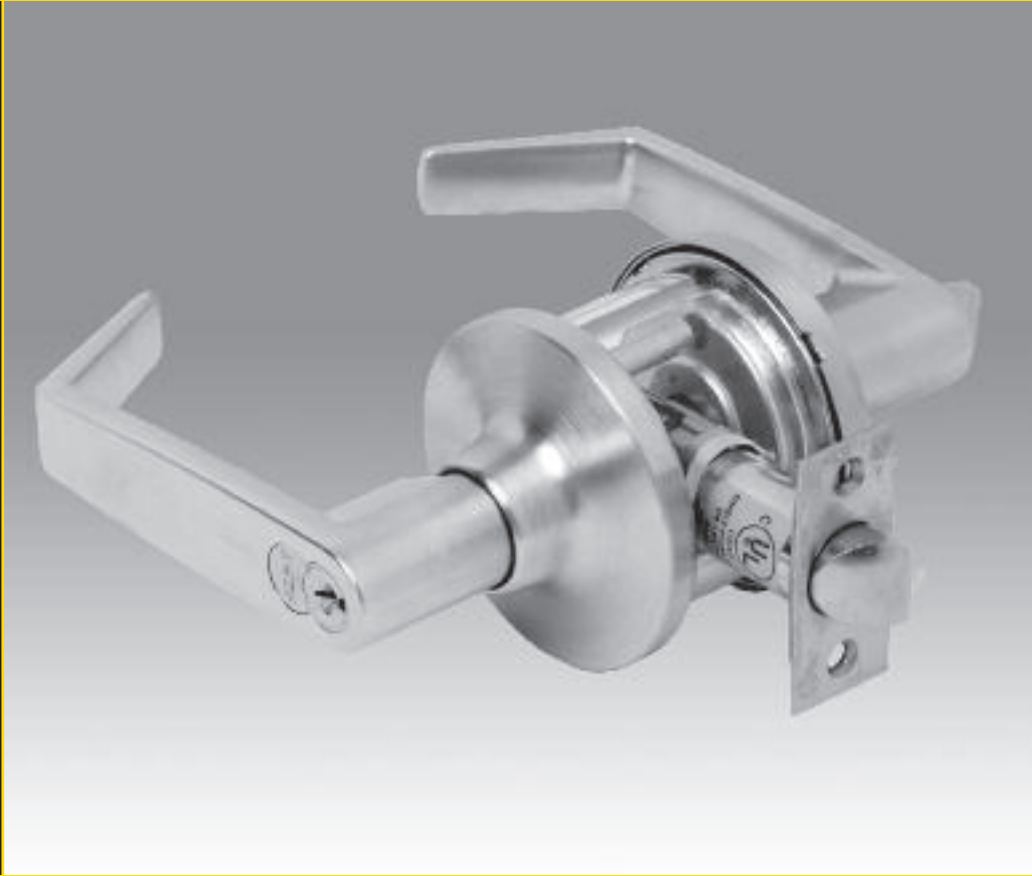

# SK SERIES

LIGHT/MEDIUM DUTY COMMERCIAL



**FEATURES**

**Features & Benefits**

- Universal latch easily adjusts to fit both a 2 3/4" and 2 3/8" backset.
- 3" diameter rose with no exposed mounting screws.
- Meets or exceeds ANSI/BHMA A156.2 Series 4000, Grade 2 strength and operational requirements.
- Meets ADA Title III requirements and Illinois Accessibility Standard.
- Quick rekeying with BEST® interchangeable cores.
- Listed by Underwriters Laboratories for use on a 3 hour, A label single swinging doors (4' x 8').
- Lockset reversible for either hand of door without removing keyed lever.



**5K Light/Medium Duty Lockset**

**Products protected by one or more of the following patents:**

5,590,555  
5,794,472



**SPECIFICATIONS**

**Backset:** Universal latch fits either 2 3/8" (60 mm) or 2 3/4" (70mm)

**Lock Chassis:** Tubular construction. Steel with stainless steel or brass cover

**Finishes:** **605** – bright brass, **612** – satin bronze, **613** – oxidized satin bronze, oil rubbed, **626** – satin chromium plated

**Core Housing:** Interchangeable core or key-in-knob

**Latch Bolt:** Universal 1/2" throw deadlocking latch fits both backsets. Faceplate: 2 1/4" x 1" x 5/32" with adapter for 1 1/8" wide faceplate applications

**Material:** Levers are zinc base, roses are brass or stainless steel, plated to match finish symbols. Latch face plates and strikes are stainless steel or steel. Lock chassis is steel with stainless steel or brass cover

**Levers:** 15 Lever – 5 1/8" long handle (129mm). Projection on door 2 5/8" (66mm).

14 Lever – 4 3/4" long handle (119.2mm). Projection on door 2 5/8" (66mm).

**Mounting:** 2 1/8" diameter bore for lock housing. 1" diameter for latch tube

**Rose:** **C** – 3" diameter mounting screws concealed

**Strike:** **STK** (standard) – 2 3/4" x 1 1/8" with curved lip (ANSI 115.2 for 1 3/8" doors). **S3** – 4 7/8" x 1 1/4" with curved lip (ANSI A115.2 for 1 3/4" doors). **FL** – 2 1/4" x 1 1/4" with curved lip and box and rounded corners.

**Door Thickness:** 1 3/8" to 1 3/4" (35mm to 44mm standard)

**HOW TO ORDER**

5K	7	A	15	C	STK	626	
Backset	Core Housing	Function Code	Lever	Trim Style	Strike Package	Standard Finishes	Options
5K– 2 3/8" or 2 3/4" adjustable backset	0– keyless 6– 6-pin non-IC cylinder 7– 7-pin IC housing accepts all Best cores	A– entrance D– storeroom L– privacy N– passage R– classroom 1DT– dummy trim***	14– curved return 15– contour angle return	C– 3"	STK– standard S3– ANSI FL– full lip radius strike	605 612 613 626	0B*– non-IC zero-bitted KA*– non-IC keyed alike KD*– non-IC keyed different OEM**– non-IC OEM cylinder

\* Six-pin cylinder in Schlage "C" included with 0B, KA, and KD options. Must specify "6" for core housing

\*\* Cylinder not included with OEM option. Must specify "0" for core housing.

\*\*\*Through-bolt makes it difficult to install two dummy trims on the same door with perfect alignment. Double dummy trimming may result in imperfect alignment.

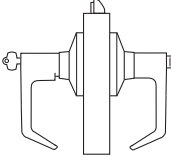
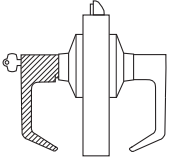
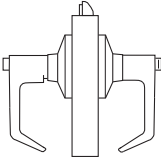
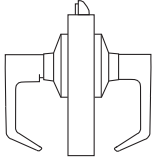
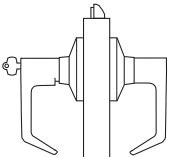
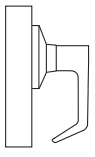

Function & Diag. (ANSI No.)	Description	Outside Lever		Inside Lever	
		Latched by	Locked by	Unlocked by	Locked by
<b>Single Keyed</b>					
<b>A-Entrance</b>  <b>F81- Grade 2</b>	<ul style="list-style-type: none"> <li>Rotating inside lever,</li> <li>Rotating outside lever—only when inside turn button is in unlocked position,</li> <li>Turning the key in the outside lever</li> </ul> <p><b>NOTE:</b> Turn button must be manually rotated to unlock the outside lever.</p>	<ul style="list-style-type: none"> <li>Turning the inside button</li> <li>Turning the key in the outside lever</li> </ul>	<ul style="list-style-type: none"> <li>Turning the inside button</li> <li>Turning the key in the outside lever</li> </ul>	Cannot be locked	Always unlocked
<b>D-Storeroom</b>  <b>F86- Grade 2</b>	<ul style="list-style-type: none"> <li>Turning key in the outside lever,</li> <li>Rotating the inside lever</li> </ul>	Always locked	Turning key in the outside lever	Cannot be locked	Always unlocked
<b>L-Privacy</b>  <b>F76- Grade 2</b>	<ul style="list-style-type: none"> <li>Rotating inside lever,</li> <li>Rotating outside lever—only when inside turn button is in unlocked position.</li> </ul>	Turn inside button	<ul style="list-style-type: none"> <li>Rotating outside slotted button,</li> <li>Rotating the inside lever.</li> </ul>	Cannot be locked	Always unlocked
<b>N-Passage</b>  <b>F75- Grade 2</b>	<ul style="list-style-type: none"> <li>Rotating inside lever,</li> <li>Rotating outside lever.</li> </ul>	Cannot be locked	Always unlocked	Cannot be locked	Always unlocked
<b>R-Classroom</b>  <b>F84- Grade 2</b>	<ul style="list-style-type: none"> <li>Rotating inside lever,</li> <li>Turning the key in the outside lever when outside lever is locked,</li> <li>Rotating outside lever when not locked by key.</li> </ul>	Turning key in the outside lever	Turning key in the outside lever	Cannot be locked	Always unlocked
<b>1DT-Single Dummy Trim</b>  <b>Grade 2</b>	<p>This is a single, surface-mounted lever for an inactive door or a non-latching door.</p> <p><b>NOTE:</b> Through-bolt makes it difficult to install two dummy trims on the same door with perfect alignment. Double dummy trimming may result in imperfect alignment.</p>				

## STRIKES &amp; DOOR PREPARATION



**STK Strike**  
(Supplied Standard)

**Dimension:** Conforms to ANSI 115.2 for 1 3/8" doors (2 3/4" x 1 1/8" with curved lip and box)

**To order with lockset:**  
Designate "STK"



**S3 Strike**  
(ANSI Strike)

**Dimension:** Conforms to ANSI 115.2 for 1 3/4" doors (4 7/8" x 1 1/8" with curved lip)

**To order with lockset:**  
Designate "S3"



**FL Strike**  
(Full Lip Radius Strike)

**Dimension:** 2 1/4" x 1 1/4" with full curved lip and rounded corners

**To order with lockset:**  
Designate "FL"

## CORMAX™ PATENTED KEYING SYSTEM

One of the greatest threats to key control within your facility is the unauthorized duplication of keys; one simple solution is the use of the CORMAX™ Patented Keying System.

Very seldom can a single product meet all of your exact needs, and often your level of convenience must be sacrificed to fit the capabilities of the product. The CORMAX Patented Keying System provides you with a significant amount of flexibility, enabling a solution that fits your unique balance between security and convenience.

The CORMAX Patented Keying System is available in two series of keyways, the M Series and the X Series. Each series offers a different blend of features. For example the CORMAX Patented Keying System can provide geographic exclusivity to the customer to help you maximize convenience while optimizing your security.



**CORMAX™**  
Patented Keying System

**M Series Keyway Features**

- Patented keys operate both CORMAX and Standard BEST cores (backward compatibility) with existing BEST keyway (J,K,L,M only). Standard keys do not operate CORMAX cores.
- Available in large bow, long blade, and long nose key blanks to work with special applications.
- Available in core designs for use in special application locks, such as high security mortise, hotel cylinders, and glass display-case locks.
- Utilizes the same combining kits and key cutting equipment as the Standard BEST keyways.
- M Series keys operate CORMAX cores and Standard (non-patented) BEST cores. Standard key blanks do not operate CORMAX cores.

**X Series Keyway Features**

- Distinctive key design includes thicker key blanks with larger bow for added strength and easier handling.
- Keyways are unique to CORMAX Patented Keying System offering even higher key duplication protection.
- CORMAX keyways utilize the standard combining kit, minimizing the expense of system changeover.
- X Series keys operate CORMAX cores only.

**STANLEY**

Security Solutions

Stanley Security Solutions, Inc.

6161 E. 75th Street Indianapolis, Indiana 46250  
www.stanleysecuritysolutions.com • © 2012 Stanley Security Solutions, Inc.

10M R0712  
BAS012